



A Solid-State Operational Amplifier of High Stability

DC AMPLIFIERS play a role of great importance in instrumentation where they permit observation of low-level potentials not only from regular electrical sources but from mechanical, chemical and biological sources as well. In analog computer work these amplifiers are used to simulate mathematical operations such as integration and summing. They are also invaluable for increasing the sensitivity of voltmeters and recorders, or isolating them from the signal source. For all of these applications, though, the amplifier must have a high degree of gain stability and very low intrinsic voltage- or current-offset to permit the accurate observation of the desired signal.

SEE ALSO:
Telephone
Test Set, p. 6

A new dc amplifier has been designed which achieves greater reliability and accuracy than previously available in a solid state device of this type. A maximum drift level of 1 microvolt per week at constant temperature and a temperature coefficient of but one-half microvolt per °C with a 100 kilohm summing point impedance constitute an order of magnitude improvement over previous all-solid-state dc amplifiers. The amplifier is designed with plug-in modules that permit a wide variety of applications. It has a gain stability of $\pm .01\%$ per week, is extremely reliable, and is unaffected by mounting position or external vibration, as no mechanical choppers or vacuum tubes are used.

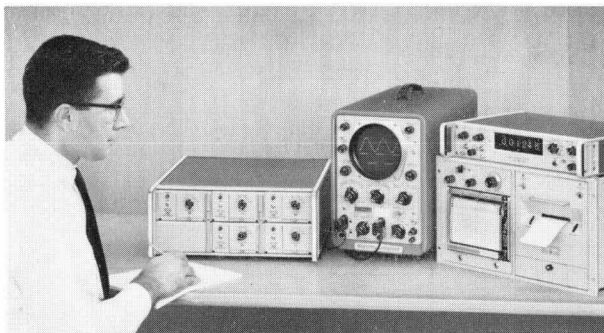

Fig. 1. New solid-state dc amplifiers (group of five in case at left) have high stability, low drift, fast recovery on large overloads, and use panel plug-in modules to adapt to many uses. Unit is produced by -hp-'s Dymec division.

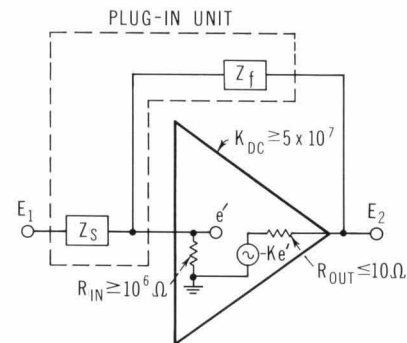

Fig. 2. Basic circuit arrangement of new amplifier. Feedback impedances are in plug-ins to permit a variety of uses for amplifier.

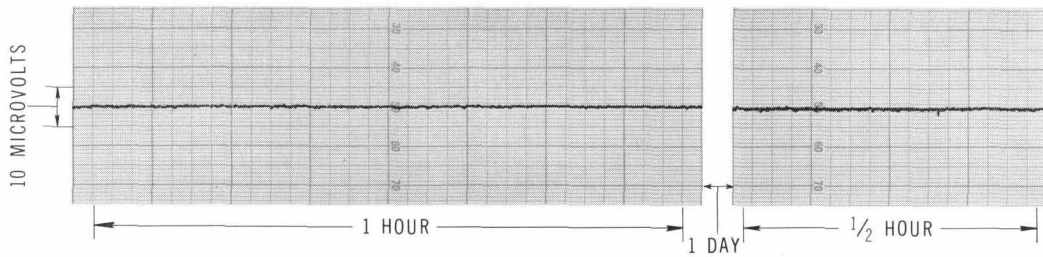

Fig. 3. Record showing typical stability achieved by new amplifier over long intervals under room conditions. Record made with new amplifier operated in high-gain position ($\times 1000$) using M2 plug-

in with output network to give noise bandwidth of 1.0 cps. Drift and gain are within 1 microvolt for 24-hour interval shown. Record begins 30 minutes after amplifier turn-on.

Special attention has also been paid to overload recovery time which is of vital importance in commutated systems. In such a system, an overload voltage for a particular channel may place a slow-recovery-time amplifier out of operation for several succeeding channels, and thereby lose important data. In the new amplifier recovery time is shorter than 1 millisecond in most cases with input overloads as high as 300 volts.

The amplifier has a self-contained power supply which requires only 4 watts of ac power, resulting in negligible internal temperature rise, and is encased in a compact modular cabinet suitable for both rack and bench use. A combining case that holds up to 6 of the amplifiers in an overall height of but 7 inches permits the amplifiers to be carried

or installed in a rack or used on a bench.

PLUG-IN FUNCTION SELECTION

The basic circuit arrangement of the amplifier is shown in Fig. 2. The feedback impedances Z_f and Z_s are located in plug-in units which thus determine the overall characteristics of the amplifier. In three of the plug-in units the feedback impedances have been selected to give the amplifier the gains and bandwidths listed elsewhere herein. In the fourth unit jacks are provided on the unit panel so that the user can merely plug in the impedances that will give a desired operational mode for the amplifier. For example, to integrate an electrical signal a resistor would be used for Z_s and a capacitor for Z_f .

The forward transfer function E_2/E_1 is the ratio of Z_f to Z_s , a relation which occurs when the ampli-

fier gain K and input impedance are very large, and the output impedance is small. The new amplifier more than meets these requirements since its nominal dc gain is 100 million, its input resistance is above 1 megohm, and its output impedance is less than 10 ohms. The open-loop roll-off has been held to no more than 6 db per octave to achieve stable operation with a variety of transfer functions.

OVERLOAD RECOVERY

In data acquisition systems, rapid recovery from input signals that greatly exceed the dynamic range of the instrument is a prime amplifier requisite. As discussed in the circuitry section, the chopper amplifier is designed to recover from overload quickly by obtaining its low frequency pole by feedback, rather than using a passive RC time constant. Another factor in providing

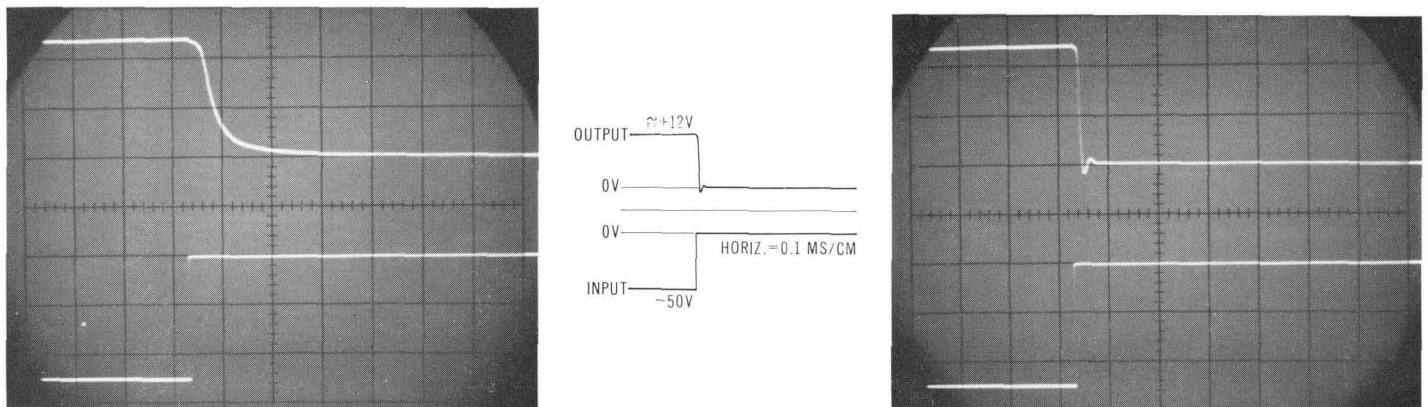

Fig. 4. Oscillograms showing typical fast recovery of new amplifier from large input overloads of 50 volts (a $500\times$ overload in $\times 100$ gain position).

Left oscillogram is for $\times 100$ gain position using M2 plug-in, right for $\times 10$ position. Sweep time is 0.1 millisecond/cm (explanatory drawing in middle).

the rapid overload recovery time obtained in the DY-2460A is a special circuit which automatically lowers the gain when the output exceeds a certain voltage level.

This is accomplished by Zener diodes in the overload circuit (Fig. 6) which are turned on for outputs greater than ± 10.5 volts. They allow current to flow to the summing point to balance out the current from the signal source, which keeps the summing point at essentially zero volts. This has the same effect as shorting the output of the amplifier to the input and reducing the gain to zero. The amplifier phase

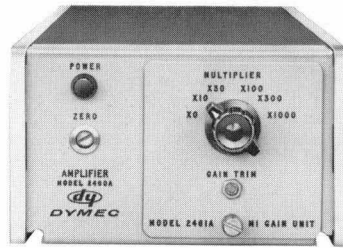

Fig. 5. Panel view of new DY-2460A amplifier with M1 plug-in.

response has been carefully controlled to permit doing this without instability, as the system under these conditions has 160 db of loop gain.

With inputs up to 300 volts the overload circuit will prevent the

amplifier from saturating with any gain setting for the M1 and M2 plug-in. Total recovery time (Fig. 4) then consists of $20 \mu s$ to turn off the overload circuit, plus the step response time of the amplifier to go from the limited output of 10.5 volts to zero which is a function of gain setting ($\frac{1}{4}$ millisecond to settle to 0.1% for the M1 plug-in at a gain of 100). Additional diodes in the overload circuit prevent the Zener leakage current from altering the gain of the amplifier in its linear region and reducing the $\pm 0.01\%$ linearity specification. In cases where the input exceeds 300 volts, clamp-

AMPLIFIER PLUG-INS

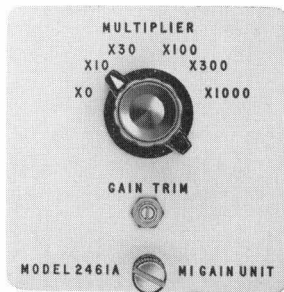

M1 GAIN UNIT

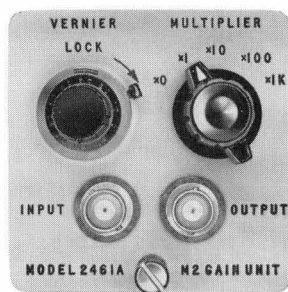

M2 GAIN UNIT

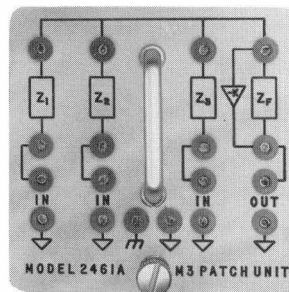

M3 PATCH UNIT

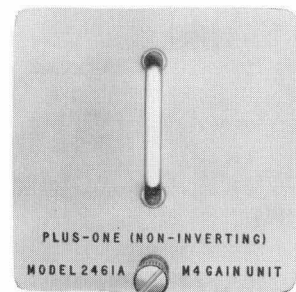

M4 GAIN UNIT

To adapt the new amplifier to a wide range of applications, four plug-in units have been designed. These units contain the feedback and input impedances Z_f and Z_s as described elsewhere in this article, and therefore determine the transfer function of the amplifier. The plug-ins fit into a recess in the front panel and are secured by a thumb-screw.

DATA AMPLIFIER PLUG-INS

The data systems plug-in M1 was designed for data acquisition systems where precise dc gains are needed. In addition to five gain positions between 10 and 1000, a $\times 0$ (shorted output) position is also provided. A front panel control with a range of $\pm 2\%$ trims the gain to the desired accuracy. A large amount of negative feedback is used (approximately 100 db at a forward gain of 1000) to make the amplifier characteristics essentially dependent on the feedback elements only. Through the use of high quality resistors, the M1 unit has a gain stability of

$\pm 0.01\%$ per week and is linear to $\pm 0.01\%$ under maximum load. Fast settling time permits rapid multiplexing in data systems; for example, the output reaches 0.1% of its final value in less than 250 microseconds at a gain of 100. Overload recovery is also fast, being $20 \mu s$ plus the amplifier settling time (which is a function of gain) for inputs up to 300 volts peak at any gain setting.

A unit which offers bench use convenience in that front panel input and output as well as rear panel connectors are provided is the M2 plug-in. Any gain setting between 1 and 11,000 can be obtained by its control arrangement consisting of a 10-turn potentiometer and dial along with the $\times 1$ through $\times 1000$ decade multiplier. Gain stability, linearity, settling time, and overload recovery time are the same as the M1 unit.

OPERATIONAL PLUG-IN

For using the amplifier in its operational sense (i.e., as a mathematical

operator) the M3 patch unit plug-in is useful. Front panel terminals are provided for the feedback impedance and up to three input impedances, as well as three input, output, and ground connections. Integrators, non-linear shaping networks, summers, and multipliers may be easily constructed by inserting the proper components, or several amplifiers may be patched together as an analog computer. The three inputs and the output are also available on the rear connector plug.

ISOLATION PLUG-IN

For applications where extreme isolation is needed between source and load the M4 plus-one unit offers an input impedance of greater than 10^{10} ohms and 300 kc bandwidth. With a 100K load the dc gain is accurate to two parts in a million; which, for example, would allow its use as a buffer amplifier for a voltage standard. The ac gain accuracy is also high, being $\pm 0.1\%$ at 1 kc.

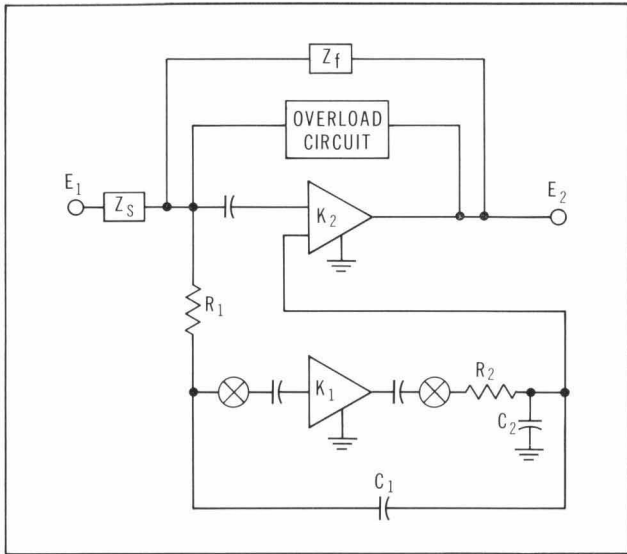

Fig. 6. Basic circuit arrangement of new DY-2460A Amplifier.

ing diodes are provided at the summing point to prevent amplifier damage.

PHOTOCONDUCTOR CHOPPER

In order to make the amplifier well-suited to use in the microvolt region, a chopper amplifier for low frequency signals precedes the main amplifier. The chopper amplifier (K_1 in Fig. 6) modulates the dc and low frequency signals, amplifies them in an ac-coupled amplifier, and reconstructs the original signal in the demodulator for a dc-to-dc gain of 10^4 . In a system like this the only location where dc offset is significant is in the input modulator or chopper circuit. Any drift occur-

ring after the chopper amplifier is divided by 10^4 when the offset is referred to the input.

The design of dc amplifiers using chopper stabilization has advanced rapidly in the past few years with the use of solid-state components; but in cases where drift must be kept to a low level, mechanical choppers have still provided the best solution up to now. However, the use of photoconductor choppers, which *-hp-* has successfully used in the 425A Micro-voltmeter¹ and 412A VTVM², permits extremely low drift levels without any of the leakage current problems and attendant offset which plague other

types of solid-state choppers. The new amplifier combines the photoconductors with a neon oscillator light source to provide a completely solid-state device with the ensuing advantages of long life, very low power consumption, and small size; and a drift level of one microvolt per week! Further, the chopping frequency is completely independent of line frequency, thus eliminating the problem of 60 cps and its harmonics producing dc offsets. To complement the low level capabilities of the photoconductor chopper, careful attention to layout and use of high quality insulating materials has been necessary to achieve microvolt zero stability under adverse environmental conditions such as high humidity.

CHOPPER AMPLIFIER

In an operational amplifier it is desirable to have the gain of the drift-free chopper amplifier as high as possible to reduce the effective drift of the main amplifier, and to make the dc loop gain very large. The gain is limited, however, by the fact that the chopper amplifier must go through gain crossover (0 db

1. John M. Cage, "An Increased-Sensitivity Micro Volt-Ammeter using a Photoconductor Chopper," Hewlett-Packard Journal, Vol. 9, No. 7, March, 1958.
2. Donald Norgaard, "A Precision DC Vacuum-Tube Voltmeter with Extended Sensitivity and High Stability," Hewlett-Packard Journal, Vol. 10, No. 11-12, July-August, 1959.

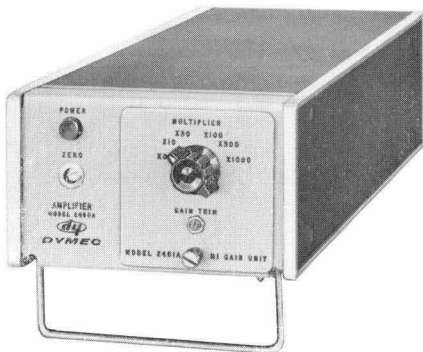
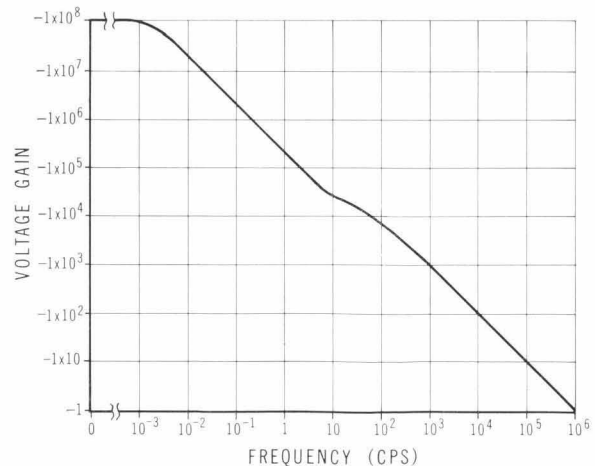

Fig. 7 (at left). New DY-2460A Amplifier in typical bench operating position.

Fig. 8 (at right). Typical open-loop gain-band width characteristic of DY-2460A Amplifier.



gain) several octaves below the carrier frequency to avoid intermodulation distortion. The usual approach has been to make the time constant R_2C_2 (Fig. 6) of such a size that its 3 db point occurs at a frequency determined by dividing the desired gain-crossover frequency by the dc gain of the chopper amplifier. For a chopper amplifier gain of 80 db and a gain-crossover fre-

quency of 15 cps, a time constant of 106 seconds would be required. This would result in a long overload recovery time, as well as requiring a physically large capacitor.

In the DY-2460A amplifier, the chopper amplifier 3 db point is determined by the R_1C_1 time constant multiplied by the dc gain in an integrator-type feedback loop. This technique allows a small capacitor

to be used (C_1 is only .027 μ fd) and also has the advantage of having the gain-crossover frequency fixed, independent of the amount of dc gain.

The carrier amplifier, K_1 , is direct-coupled and uses dc feedback for bias stability and ac feedback to raise the input impedance at the summing point to maintain the accuracy of the overall system. Low noise sili-

(Concluded on page 7)

SPECIFICATIONS

DYMEC MODEL DY-2460A AMPLIFIER

(WITHOUT PLUG-IN)

OPEN-LOOP GAIN (Inverting): 5×10^7 at dc; 7×10^3 at 40 cps; 1 at 1 mc; values are minimum values for load impedances $> 1K$.

OPEN-LOOP INPUT IMPEDANCE: 1M at dc; 150K at 1 kc; minimum values. Shunt capacitance 60 pf max.

OPEN-LOOP OUTPUT IMPEDANCE: 10 ohms max from dc to 10 kc; 50 ohms max from 10 kc to 1 mc.

INPUT NOISE: 4 μ v p-p max, 0 to 1 cps; 10 μ v rms max, 0 to 1 kc; values referred to summing point. Sum point to ground res. $< 100K$.

ZERO DRIFT: Constant temp: 1 μ v/week max; Temp. Coeff: 0.5 μ v/ $^{\circ}$ C max; values referred to summing point. (2-hr. warm-up.) Sum point to gnd res. $< 100K$.

ZERO ADJUSTMENT: $\pm 20 \mu$ v referred to summing point.

CHOPPER FREQUENCY: 190 to 300 cps, non-synchronous.

DC OUTPUT CAPABILITY: Voltage: ± 10 v; Current: ± 10 ma; values for range from dc to 10 kc; 6 db/octave decrease from 10 kc to 1 mc.

OVERLOAD: Amplifier Limiting: ± 10.5 to ± 11.5 v output; Recovery: Equal to rise time plus 20 μ s. (5 ma max to sum point); Overload Lamp Indication*: ± 10.0 to ± 10.5 v threshold; Overload Signal*: ± 35 v normal, ± 1.5 v overload, at rear connector. 5 ma available. (*With Option M1.)

OUTPUT LOAD: Max Capacity Load for Stability: 0.1 μ f for gain > 10 ; 0.01 μ f for gain < 10 ; Short Circuit: Does not damage instrument.

REAR CONNECTOR: Following circuit connections provided at rear connector. (Mating connectors listed under DY-2461A plug-in units.)

1. Output Common
2. Output
- 3, 5, 8, 10. Chassis ground
4. AC line (high)
6. Capacitor to chassis ground
7. Overload (with Option M1)
9. AC line (low)
- A1. Input 1 (normal)
- A2. Input 2, DY-2461A-M3 only
- A3. Input 3, DY-2461A-M3 only

OPERATING CONDITIONS: 0 to 55 $^{\circ}$ C ambient temperature range. Up to 95% relative humidity at 40 $^{\circ}$ C.

POWER REQUIRED: 115/230v $\pm 10\%$, 50 to 1000 cps, 4 watts approx.

DIMENSIONS: 5" w. \times 3" h. \times 16" d. behind panel. Up to six amplifiers may be mounted in Combining Case (see Accessories Available).

WEIGHT: (Includes one plug-in.) Net wt, 6 lb; shipping wt, 12 lb.

FINISH: Light grey baked enamel. Black-filled engraved control titles.

ACCESSORIES AVAILABLE: (Order by stock number)

1. **Combining Case:** Contains up to 6 amplifiers (see photo page 1). Includes mating rear connectors for each unit. Height 7", width 16 $\frac{3}{4}$ ", depth behind panel 16 $\frac{3}{8}$ ". Supplied with adapters for mounting in 19" rack. Stock No. 8048-0029, \$200.00.

2. **Filler Panel:** For use with Combining Case; covers one unoccupied panel opening. Stock No. 5060-0792, \$3.00 each.

3. **Control Panel Cover:** For use with Combining Case. Covers all amplifiers, includes carrying handle. Stock No. 5060-0828, \$23.00.

OPTIONS: **Overload Indication:** Front panel lamp indication and output signal provided under overload conditions. Order DY-2460A-M1, \$430.00.

PRICE: DY-2460A Amplifier (less plug-in), \$395.00.

DY-2461A-M1

DATA SYSTEMS PLUG-IN

GAIN (Inverting): Fixed Settings: 10, 30, 100, 300, 1000 ($\times 0$ position shorts output). Adjustment: $\pm 2\%$ on each range (front panel screwdriver control).

DC GAIN ACCURACY: $\times 30 \pm 0.6\%$; $\times 100 \pm 0.6\%$; $\times 300 \pm 1.3\%$; $\times 1000 \pm 1.3\%$; when calibrated on $\times 10$ range, temp. range 0 to 55 $^{\circ}$ C.

DC GAIN STABILITY: $\pm 0.01\%$ per week at constant temp. $\pm 0.01\%/^{\circ}$ C max. temp. coeff.

DC LINEARITY: $\pm 0.01\%$ at any gain setting.

INPUT RESISTANCE: 100K $\pm 0.2\%$.

INPUT CAPACITANCE: 50 pf nominal.

MAXIMUM INPUT: 300v peak or 220v rms (whichever is less).

OUTPUT RESISTANCE: 50 milliohms max. BANDWIDTH AND SETTLING TIME: (Signal must be within output capability; see DY-2460A spec.)

Gain	Minimum 3 db Bandwidth	Maximum Settling Time to 0.1%*
$\times 1$	50 kc	25 μ s
$\times 30$	15 kc	75 μ s
$\times 100$	5 kc	250 μ s
$\times 300$	1.5 kc	750 μ s
$\times 1000$	500 cps	2.5 ms

(*For settling time to 1% multiply by 0.67. For 0.01% use 1.3.)

CHOPPER INTERMODULATION DISTORTION: Less than 0.2% of reading at gain of 10, over frequency range 100 to 300 cps.

ACCESSORIES AVAILABLE: **Mating Rear Connector** (not required if Combining Case used). Stock No. 9300-0024, \$9.00.

PRICE: DY-2461A-M1 Data Systems Plug-In, \$85.00. Combined with DY-2460A Amplifier, \$480.00.

DY-2461A-M2

BENCH-USE PLUG-IN

GAIN (Inverting): Fixed Settings: 1, 10, 100, 1000 ($\times 0$ position shorts output); Vernier: Extends gain for each setting to 11, 110, 1100, 11000 respectively.

DC GAIN ACCURACY: $\times 1 \pm 0.6\%$; $\times 10 \pm 0.6\%$; $\times 100 \pm 1.3\%$; $\times 1000 \pm 2.0\%$; vernier at 1. Temp. range 0 to 55 $^{\circ}$ C.

DC GAIN STABILITY: $\pm 0.01\%$ per week at constant temp. (Vernier at 1.) $\pm 0.01\%/^{\circ}$ C max temp coeff.

DC LINEARITY: $\pm 0.01\%$ at each setting (Vernier at 1).

VERNIER ACCURACY: $\pm 3\%$.

INPUT RESISTANCE: 100K $\pm 0.2\%$.

INPUT CAPACITANCE: 50 pf nominal (reduced to 5 pf nominal if connection to rear connector is removed).

MAXIMUM INPUT: 300v peak or 220v rms (whichever is less).

OUTPUT RESISTANCE: 50 milliohms max. BANDWIDTH AND SETTLING TIME: (Signal must be within output capability; see DY-2460A spec.)

Gain	Minimum 3 db Bandwidth	Maximum Settling Time to 0.1%*
$\times 1$	50 kc	25 μ s
$\times 10$	50 kc	25 μ s
$\times 100$	5 kc	250 μ s
$\times 1000$	500 cps	2.5 ms

(*For settling time to 1% multiply by 0.67. For 0.01% use 1.3.)

CHOPPER INTERMODULATION DISTORTION: Less than 0.2% of reading at gain of 10, over frequency range 100 to 300 cps.

ACCESSORIES AVAILABLE: **Mating Rear Connector** (not required if Combining Case used). Stock No. 9300-0024, \$9.00.

PRICE: DY-2461A-M2 Bench Use Plug-In, \$125.00. Combined with DY-2460A Amplifier, \$520.00.

DY-2461A-M3

PATCH UNIT PLUG-IN

Patch panel provides connections for up to 3 inputs and 1 feedback path. Inputs, output, circuit ground and chassis ground available at both front panel and rear connector. Summing point available at front panel only. Overload signal at rear only.

ACCESSORIES AVAILABLE: **Mating Rear Connector** (not required if Combining Case used). Stock No. 9300-0025, \$14.00. ACCESSORIES FURNISHED: **Four Component Plugs**, stock No. 8050-0105.

PRICE: DY-2461A-M3 Patch Unit Plug-In, \$75.00. Combined with DY-2460A Amplifier, \$470.00.

DY-2461A-M4

PLUS-ONE GAIN PLUG-IN

GAIN: $\times 1$. Non-inverting. DC GAIN ACCURACY: $\pm .005\%$ into 1K; $\pm .0002\%$ into 100K; includes linearity, long term stability, 0 to 55 $^{\circ}$ C.

AC GAIN ACCURACY: $\pm .1\%$ into 100K (at 1v rms and 1 kc).

BANDWIDTH: (Signal must be within output capability; see DY-2460A spec.) 0.1 db at 5 kc; 3 db at 300kc.

INPUT RESISTANCE: 10¹⁰ ohms, for relative humidity up to 70% at 40 $^{\circ}$ C.

INPUT CAPACITANCE: 50 pf nominal (reduced to 5 pf nominal if connection to rear connector removed).

OUTPUT RESISTANCE: 50 milliohms max. PHASE SHIFT: .5 $^{\circ}$ at 1 kc; .5 $^{\circ}$ at 10 kc; 4 $^{\circ}$ at 100 kc. (Signal must be within output capability; see DY-2460A spec.)

CHOPPER INTERMODULATION DISTORTION: Less than 0.02% of reading over frequency range 100 to 300 cps.

OVERLOAD RECOVERY: Maximum input for 1 ms recovery (to 0.1%) ± 300 v.

ACCESSORIES AVAILABLE: **Mating Rear Connector** (not required if Combining Case used). Stock No. 9300-0024, \$9.00.

PRICE: DY-2461A-M4 Plus-One Gain Plug-In, \$35.00. Combined with DY-2460A Amplifier, \$430.00.

All prices f.o.b. Palo Alto, California
Data subject to change without notice.

DYMEC

Division of Hewlett-Packard Co.
395 Page Mill Road
Palo Alto, Calif.

A PORTABLE FREQUENCY-RESPONSE TEST SET



Fig. 1 (above). -hp- 3550A Portable Test Set with panel cover removed.

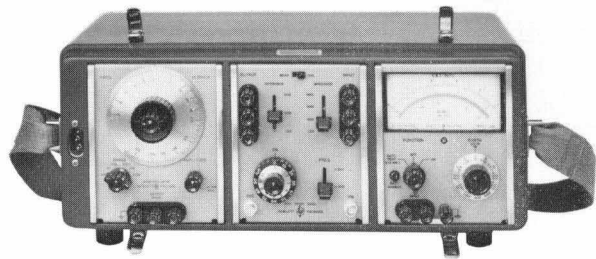

Fig. 2 (at left). -hp- 3550A Portable Test Set measures insertion loss and frequency response of telephonelines over range from 50 cps to 560 kc. Unit matches 135, 600, and 900-ohm lines, is transistorized and battery-operated.

THE new -hp- 3550A Portable Test Set, designed specifically for transmission line testing, will find wide use in alignment and maintenance of multichannel communication systems. The test set consists of a wide-range oscillator, an electronic voltmeter, and a patch panel containing attenuators and line-matching transformers. The battery-operated instruments are completely transistorized, contributing to the light weight and compactness of the set.

The 30-pound weight is a distinct advantage when the set is to be hand-carried into the field or into awkward to reach places, such as airplane structures or isolated telephone repeater stations. The rugged aluminum case is splash proof since no vent holes are required for the small amount of heat generated by the transistorized instruments (Figs. 1 and 4).

The oscillator and voltmeter op-

erate from internal rechargeable batteries, or from a 115/230 volt ac line which also charges the batteries automatically. With batteries fully charged, the Portable Test Set may be operated continuously for at least 40 hours.

The HO-204B audio oscillator used in the test set is a rechargeable version of the familiar -hp- 204B battery-powered RC oscillator*. This oscillator covers a frequency range from 5 cps to 560 kc with an output power of 10 milliwatts (2.5 v rms) into a 600 ohm load. Frequency accuracy is $\pm 3\%$ while the amplitude/frequency response is $\pm 3\%$, which enables frequency response measurements to be made without monitoring and continually resetting oscillator output voltage.

The included 403B transistorized ac voltmeter is a new, versatile, gen-

eral purpose instrument designed for laboratory and field use. Its frequency range is 5 cps to 2 Mc with full scale voltage ranges from 1 mv to 300 v and a db range from -72 to $+52$ dbm. Accuracy is within $\pm 2\%$ of full scale over a temperature range of 0°C to 50°C for frequencies between 10 cps to 1 Mc. This accuracy is traceable to -hp-'s own individually calibrated meters. A floating input permits isolated ground measurements up to a maximum of 500 v dc.

The heart of the Portable Test Set is the Model 353A Patch Panel, which adapts the oscillator and voltmeter to specialized transmission line testing. The patch panel has input and output sections which act as source and receiver for the transmission line.

The output section has an attenuator and impedance matching transformers which match the oscillator's 600 ohm output impedance to line impedances of 135, 600, and 900 ohms. The 135 ohm impedance level is associated primarily with carrier system testing while the 600 ohm impedance is for long distance and high quality program lines; the 900 ohm impedance is for local subscriber loops. The center-tapped transformers are balanced to better than 40 db on the output windings.

The patch panel is diagrammed in Fig. 3. The oscillator signal passes through two cascaded T-section attenuators to the output (source)

*Cochran, D. S., "The Transistorized RC Oscillator," Hewlett-Packard Journal, Vol. 13, No. 5, Jan., 1962.

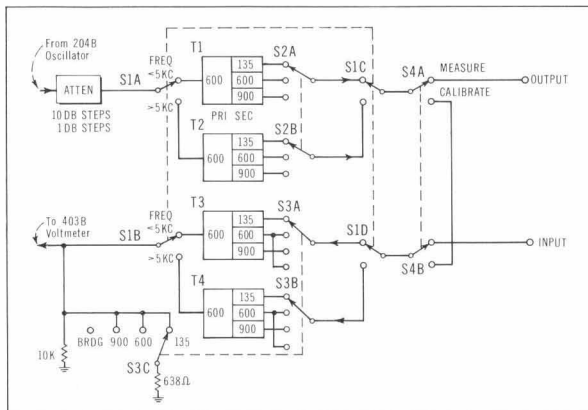
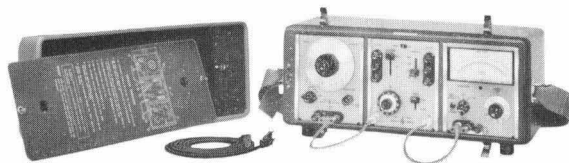

Fig. 4 (above). Test set has splash-proof case. Cables stow in cover.

Fig. 3 (at left). Skeleton schematic of patch panel in new test set.



transformer. One attenuator section attenuates the signal in 1 db steps, while the other provides 10 db steps

for a total maximum attenuation of 110 db. Two transformers cover the wide frequency range involved,

transformer T1 operating from 50 cps to 5 kc while T2 is designed for use from 5 kc to 560 kc.

The input (receiver) section uses transformers identical to the output section, providing balanced input at impedance levels of 135, 600, and 900 ohms in addition to a bridging impedance (10 k). In all positions except bridging, the voltmeter reads across the 600 ohm load in the trans-

(Continued on next page)

AMPLIFIER (from page 5)

con transistors operating at low collector current levels for optimum noise figure are used in the input stages, as well as low noise metal film resistors. The input circuit of the amplifier is carefully constructed to prevent the development of leakage currents, thermoelectric potentials, and thermal gradients which would affect the zero stability of the amplifier. Teflon insulation is extensively used, and capacitors at the input are hermetically sealed polystyrene units.

The photoconductors are encased in a special zinc-die-casting which also contains the neon oscillator circuit in a separate cavity. Therefore, only dc appears on the leads entering the die-cast chopper block, and radiation of carrier frequency signals from the neon circuit into the carrier amplifier is reduced to a negligible amount.

MAIN AMPLIFIER DESIGN

The main amplifier (K_2) provides a gain of 10^4 at dc and rolls off at 6 db per octave beginning at 100 cps. The input stage of the main amplifier is a differential amplifier driven by emitter followers to raise the input impedance. The transistors are again run at low current levels to minimize noise, and to reduce the

drift due to changes in beta with temperature. This stage is followed by an RC network which provides a pole at 100 cps and a zero at 50 Kc, and drives a feedback pair which provides flat gain out to several megacycles. The output stage is a feedback triplet with push-pull emitter follower output. This stage has a zero in the feedback path which occurs at 50 Kc to continue the 6 db slope, and also maintains the loop gain at high frequencies to reduce the output impedance. As noted, extensive use has been made of local feedback to fix the gain and frequency response within close limits, and insure stable operation over long periods of time.

OVERLOAD INDICATOR

An optional front panel overload light is available which turns on when the output exceeds ± 10 volts. In this option an overload signal also appears on the rear connector where it may be used to trigger a remote indicator if desired.

CONSTRUCTION STYLE

The amplifier is constructed in the new *-hp-* modular cabinet which is suitable for both rack and bench use, and occupies a minimum of front panel space. Six DY-2460A amplifiers in a combining case require

only 7" of vertical panel space in a 19" rack (Fig. 1).

To facilitate servicing, the amplifier and power supply are built on three printed circuit boards which are accessible from both sides while operating. No internal adjustments are used on the amplifier, the front panel zero and gain being the only controls. In order that ground loop currents may be reduced to a minimum, the circuit ground is floating from the case with both grounds brought out to the rear connector.

The self-contained power supply is fully solid-state and draws less than 4 watts under maximum loading conditions. The voltages to the amplifying stages are regulated which, with the large amount of feedback inherent in the amplifier, makes the device virtually insensitive to line variations.

ACKNOWLEDGMENT

The design work was done in the Advanced Research and Development Division of the Hewlett-Packard laboratories by Albert J. Reichner and the undersigned, with some initial circuit design by John H. Caldwell. Tom Deaver performed the mechanical design, and Richard Y. Moss of Dymec transferred the instrument from the lab into production at Dymec.—Robert J. Streblov

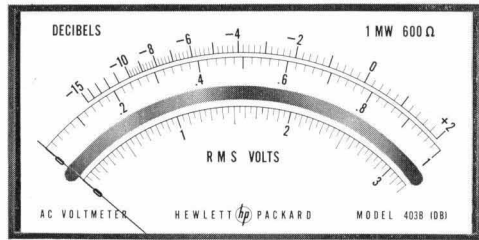

Fig. 5 (at left). Mirror-scale meter face in test set volt meter is individually calibrated on -hp- automatic meter calibrator. Face has db scale uppermost.

former secondary so that it reads dbm directly regardless of line impedance. In the bridging position, the transformer has a 1:1 turns ratio so that the voltmeter reads input voltage directly (the dbm scale then is correct only for 600 ohm lines, a correction factor being applied for other line impedances).

Switch S1 changes the transformers in both the input and output sections for the two frequency ranges involved. The 5 kc break point corresponds to the range switch on the oscillator. Switch S4, Meas-Cal, connects the input and output terminals together to allow setting a reference level on the voltmeter. In this manner, the insertion

losses of the transformers are accounted for.

Insertion loss and frequency response measurements are made easily with the 3550A Portable Test Set. Fig. 6a illustrates the connection between the Test Set and a telephone transmission line when no dc voltage is present on the line. Fig. 6b illustrates the connection between the test set and a telephone line with dc voltage present. The transformers in the patch panel are not designed for dc current, so that holding coils and blocking capacitors are used in this situation. The insertion loss of the holding coils may be calibrated out, where a transmission line loop is being

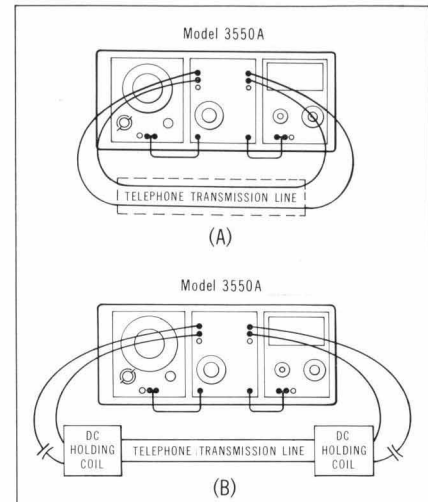

Fig. 6. Test set connections to telephone lines when dc is present (a) and not present (b).

measured, by shorting the input end of the line to the output end.

The design team for the Model 3550A consisted of Noel M. Pace, Robert B. Moomaw, Gale C. Hammelwright, and the undersigned, at the Loveland Division of the Hewlett-Packard Company.

—Don A. Wick

SPECIFICATIONS

-hp- MODEL 3550A

PORTABLE FREQUENCY RESPONSE TEST SET

OSCILLATOR (-hp- H07-204B)

FREQUENCY RANGE: 5 cps to 560 kc in 5 ranges. Vernier provided.

DIAL ACCURACY: $\pm 3\%$.

FREQUENCY RESPONSE: $\pm 3\%$ into rated load.

OUTPUT IMPEDANCE: 600 ohms.

OUTPUT: 10 milliwatts (2.5 v rms) into 600 ohms; 5 v rms open circuit; completely floating (isolated).

OUTPUT CONTROL: Continuously variable bridged "T" attenuator, to 40 db.

DISTORTION: Less than 1%.

HUM AND NOISE: Less than 0.05%.

TEMPERATURE RANGE: -20°C to $+50^{\circ}\text{C}$.

POWER SUPPLY: 4 rechargeable batteries (furnished). 40 hour operation per recharge (20 hours at -20°C), up to 500 recharging cycles. Self-contained recharging circuit functions automatically when instrument is connected to ac line (115 or 230v $\pm 10\%$, 50 to 1000 cps); approximately 3 watts.

DIMENSIONS: 6-3/32 inches high, 5 1/8 inches wide, 8 inches deep.

VOLTMETER (-hp- 403B-DB)

RANGE: 0.001 to 300 volts rms full scale (12 ranges) in 1, 3, 10 sequence. -75 dbm to $+52$ dbm.

FREQUENCY RANGE: 5 cps to 2 mc.

ACCURACY:

0°C to $+50^{\circ}\text{C}$

5 to 10 cps: $\pm 5\%$

10 cps to 1 Mc: $\pm 2\%$

1 to 2 Mc*: $\pm 5\%$

0°C to -20°C

5 cps to Mc*: $\pm 8\%$

METER: Responds to average value of input waveform and is calibrated in rms value of a sine wave.

NOMINAL INPUT IMPEDANCE: 2 megohms shunted by approximately 50 pf on 0.001 to 0.03 volt ranges, 25 pf on 0.1 to 300 v ranges.

OVERLOAD PROTECTION: Fuse protected.

DC ISOLATION: Signal ground may be ± 500 vdc with respect to instrument case.

TEMPERATURE RANGE: -20°C to $+50^{\circ}\text{C}$.

POWER SUPPLY: 4 rechargeable batteries and recharging circuit same as H07-204B oscillator.

DIMENSIONS: 6-3/32 in. high, 5 1/8 in. wide, 8 in. deep.

PATCH PANEL (-hp- 353A)

INPUT: (Receiver)

FREQUENCY RANGE: 50 cps to 560 kc.

BALANCE: Better than 40 db.

FREQUENCY RESPONSE: $\pm 1/2$ db, 50 cps to 560 kc.

IMPEDANCE: 135, 600, 900 ohms and Bridging (10k) center-tapped.

INSERTION LOSS: Less than $3/4$ db at 1 kc.

MAXIMUM LEVEL: $+10$ dbm (2.5 v rms at 600 ohms).

* $\pm 10\%$ on 300 v range. Use 10001A 10:1 Divider and 1011A Adapter to retain $\pm 5\%$ accuracy when measuring up to 425 v rms at 1 to 2 mc.

OUTPUT: (Source)

FREQUENCY RANGE: 50 cps to 560 kc.

BALANCE: Better than 40 db.

FREQUENCY RESPONSE: $\pm 1/2$ db, 50 cps to 560 kc.

IMPEDANCE: 135, 600, and 900 ohms center-tapped.

INSERTION LOSS: Less than $3/4$ db at 1 kc.

DISTORTION: Less than 1%, 50 cps to 560 kc.

MAXIMUM LEVEL: $+10$ dbm (2.5 v rms at 600 ohms).

ATTENUATION: 110 db in 1 db steps.

Accuracy, 10 db section: Error is less than ± 0.25 db at any step.

Accuracy, 100 db section: Error is less than ± 0.5 db at any step.

CONNECTORS: Two 3-terminal binding posts for external circuit connection and two BNC female connectors for oscillator and voltmeter connection.

DIMENSIONS: 6-3/32 in. high, 5 1/8 in. wide, 8 in. deep.

GENERAL

ACCESSORIES FURNISHED: Detachable power cord. Two cables, 12 in. long, banana plug to BNC male connectors. Splash-proof cover and storage compartment.

ACCESSORIES AVAILABLE: 5060-0797 Adapter Frame for rack mounting; 11002A Test Leads, banana plug to Alligator Clips.

DIMENSIONS: 8 3/8 in. high, 19 1/4 in. wide, 13 1/4 in. deep (with cover installed).

WEIGHT: Net 30 1/2 lbs., shipping 45 lbs.

PRICE: -hp- 3550A Test Set, \$990.00.

Prices f.o.b. factory
Data subject to change without notice.